

RoHS Compliant

REV.	DESCRIPTION	SIGN	DATE
A	NEW	Fred.Tong	17/06/20

NOTES:

- ELECTRONIC:  
CONTACT CURRENT RATING:1.5A  
CONTACT RESISTANCE: 30mohm MAX  
INSULATION RESISTANCE: 1000 Mohm MIN  
WITHSTAND VOLTAGE:AC 500V,1min.
- MECHANICAL:  
MATING FORCE:3.57KG MAX  
UNMATED FORCE:1.02KG MIN
- ENVIRONMENT CHARACTERISTICS:  
OPERATING TEMPERATURE:-55°C TO +105°C
- 料号说明: EU09F X X X X 2212

L=蓝色  
B=黑色  
1=铜壳  
2=铁壳  
3=不锈钢壳

1=端子1U"  
5=端子15U"  
6=端子30U"  
N=外壳镀镍  
A=外壳镀金

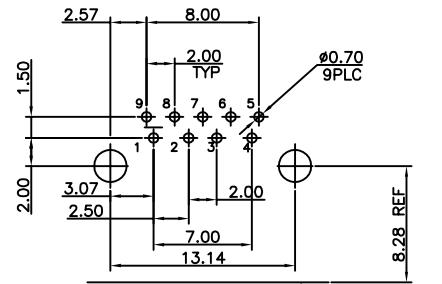
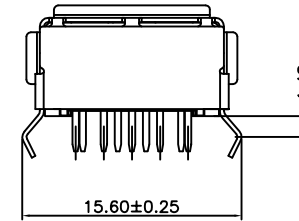
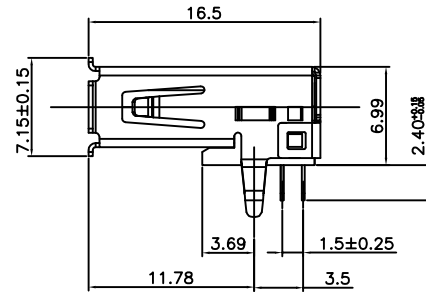
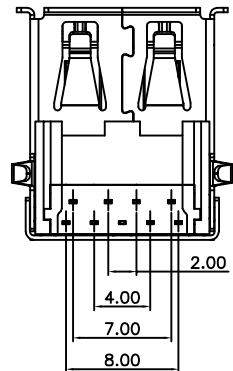
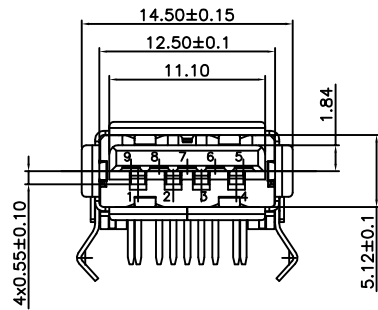
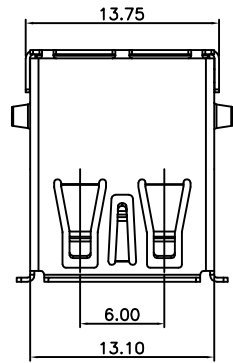

TOLERANCE: ±0.05.  
RECOMMENDED PCB LAYOUT  
(TOP VIEW)

5.MATERIAL LIST:

No.	PART NAME	QTY	MATERIAL	REMARK
3	SHELL	1	COPPER ALLOY C2680	NI PLATED
2	5PIN	9	COPPER ALLOY C2680	AU /TIN PLATED
2	4PIN	4	COPPER ALLOY C5191	AU /TIN PLATED
1	HOUSING	1	THERMOPLASTIC(LCP)	(UL 94V-0) BLUE

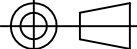
GENERAL TOLERANCES (UNLESS SPECIFIED)			DRAWN BY	DATE	 TEL: +86 0755 27801940 Mob: +86 15889397634 www.techedom.com		
ITEM	MM	INCH	Alen.Yu	17/06/20			
3 PLACE	±0.15	±0.005	CHECKED BY	DATE	TITLE: USB3.0 AF 90度 DIP铜壳蓝色LCP 无LOGO 侧弹朝前		
2 PLACE	±0.25	±0.01	Liang.Li	17/06/20			
1 PLACE	±0.35	±0.015	APPROVED BY	DATE			
0 PLACE	±0.50	±0.02	Fred.Tong	17/06/20	ANGLE OF PROJECTION 	SIZE A4	PART NO. EU09FL1N12212
METRIC U.S. MM INCHES					SCALE N/A	SHEET 1 OF 1	
THIS DRAWING CONTAINS INFORMATION THAT IS PROPRIETARY TO EDOM INCORPORATED AND SHOULD NOT BE USE WITHOUT WRITTEN PERMISSION						REV. A	