

RoHS Compliant

REV.	DESCRIPTION	SIGN	DATE
A	NEW	Fred.Tong	17/8/13

NOTES:

SPECIFICATION:

1. CURRENT RATING: 3A FOR VBUS ,0.25 FOR OTHERS
2. VOLTAGE: 100 VAC
3. TEMPERATURE RANGE: -30 °C ~ 85 °C
4. CONTACT RESISTANCE: 40 MILLIONHM MAX
5. INSULATION RESISTANCE: 100 MEGOHMS MIN.
6. LNSERTION FORCE : 5N~20N
7. UNMATING FORCE: 8N~20N
8. DURABILITY: 10,000 CYCLES

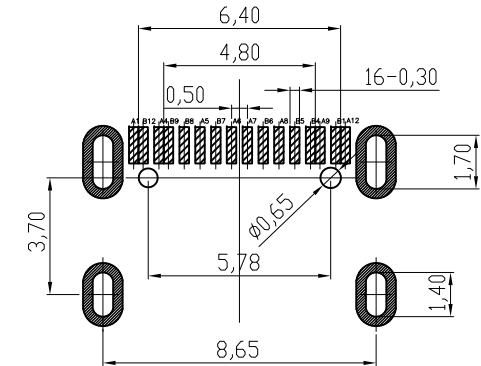
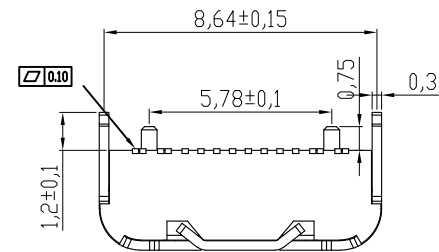
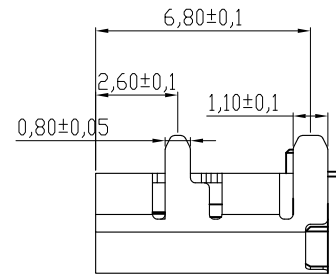
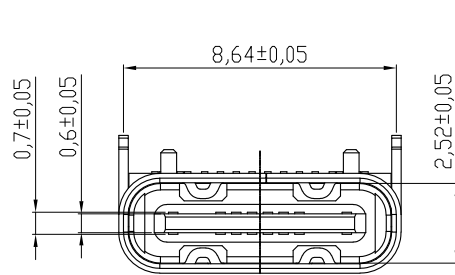
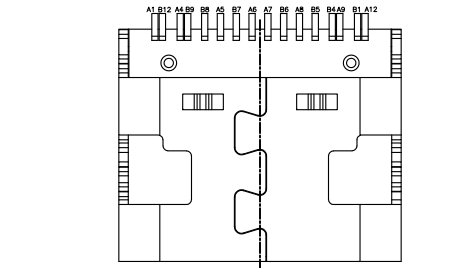

RECOMMENDED P.C.B. LAYOUT  
TOLERANCE UNSPECIFIED ±0.05mm

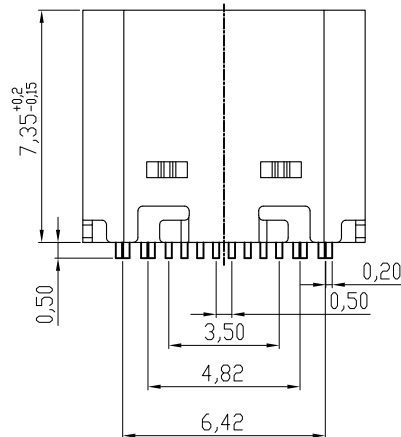

A1	GND	B12	GND
A4	VBUS	B9	VBUS
A5	CC1	B8	SBU2
A6	DP1	B7	DN2
A7	DN1	B6	DP2
A8	SBU1	B5	CC2
A9	VBUS	B4	VBUS
A12	GND	B1	GND
PIN	SIGNAL NAME	PIN	SIGNAL NAME

4	MID PLATE	1	STAINLESS STEEL	NATURE
3	SHELL	1	STAINLESS STEEL	NI PLATED
2	CONTACT	16	COPPER ALLOY	GOLD PLATED
1	HOUSING	1	THERMOPLASTIC(LCP)	(UL 94V-0)
No.	PART NAME	QTY	MATERIAL	REMARK

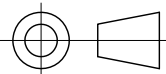
GENERAL TOLERANCES (UNLESS SPECIFIED)			DRAWN BY	DATE	 TEL: +86 0755 27801940 Mob: +86 15889397634 www.techedom.com
ITEM	MM	INCH	RuoBiaoLing	2020/11/10	
3 PLACE	±0.15	±0.005	CHECKED BY	DATE	<b>TITLE:</b> TYPE C单排16PIN SMT四脚插板有柱
2 PLACE	±0.25	±0.01	/	/	
1 PLACE	±0.35	±0.015	APPROVED BY	DATE	<b>SIZE</b> A4 <b>PART NO.</b> EU16FB3M1114
0 PLACE	±0.50	±0.02	Fred.Tong	2020/11/10	
ANGULAR ± 3'			ANGLE OF PROJECTION		<b>SCALE</b> N/A SHEEL 1 OF 2
METRIC	U.S.				
MM	INCHES				

THIS DRAWING CONTAINS INFORMATION THAT IS PROPRIETARY TO EDOM INCORPORATED AND SHOULD NOT BE USE WITHOUT WRITTEN PERMISSION

REV.  
A