

REV	ECN NO	DESCRIPTION	DATE	APPROVED
A	-	NEW RELEASED	2022.01.05	CLARA

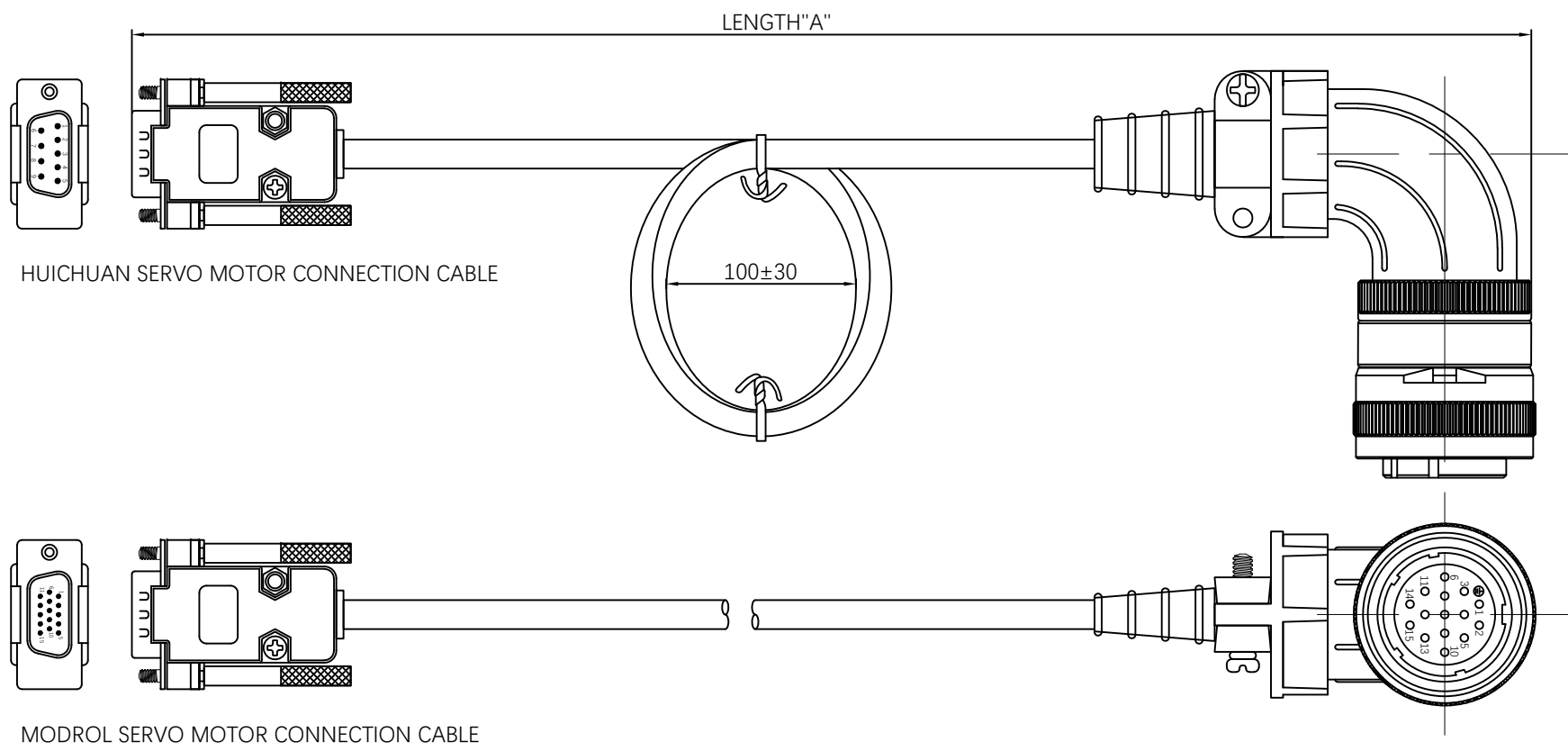

Material specifications
 Contact: Brass with gold plated
 Insulation: PA, Black, UL94V-0
 Housing: Brass with nickel plated

Mechanical properties
 Minimum bending radius: Fixed installation: 8x Cable OD
 Flexible installation: 10x Cable OD

Electrical testing of finished cable
 100% Open / Short / Miswiring testing
 Insulation resistance: DC300V 10MΩ
 Conductor resistance: 5Ω



UNMARKED TOLERANCES		TITLE		EDOM ELECTRONICS		TEL: +86 0755 27801940	
DIMENSIONS	TOLERANCE	SERVO MOTOR CABLE ASSEMBLY		Mob: +86 1588937634		www.techedom.com	
x	±0.5	CUSTOMER	-	CUSTOMER PART NO.	-		
x.x	±0.25	DRAWN BY	CLARA	PART NUMBER	-	SIZE	REV
x.xx	±0.15	CHECKED BY	BILL	DRAWING NUMBER	servo-motor-cables	A3	A
0 to 500	+15 / -0	APPROVED BY	KIMKEE	SCALE FREE	ALL DIMENSION UNIT IN MM	SHEET 1 OF 1	
> 501	+3W/-0 of length						
ANGLES							
x°	±1°						

